

**röhr**

Röhr-Bush GmbH & Co.KG  
 Dämmstraße 32  
 33397 Rietberg  
 Germany  
 Fon +49 (0) 2944 981 198  
 Fax +49 (0) 2944 981 310

### Montageanleitung A03835.01

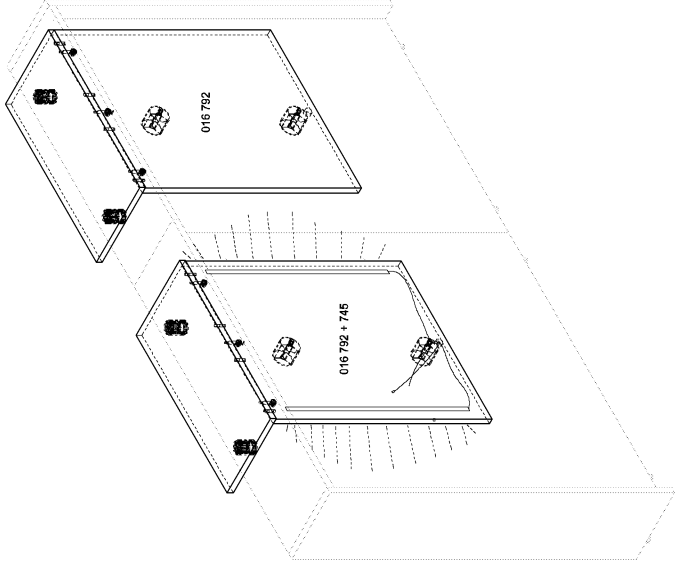

Bitte unbedingt lesen. Bei Nichtbeachtung können wir keine Gewährleistung übernehmen!  
 Bitte bewahren Sie diese Montageanleitung für die Produktkennung (Produktsicherheitsgesetz) und für evtl. spätere Rückfragen (wie z.B. Demontage) auf.  
 Bei Weitergabe bzw. Übergabe des Artikels übergeben Sie auch diese Montageanweisung.  
 Attention! It is essential to read this. In case of non-compliance we can not accept any liability.  
 Please retain these assembly instructions for product identification and all future references i.e. disassembly.  
 With all transfers or deliveries of this item these assembly instructions should always be forwarded.

0210217

**röhr**

### Montageanleitung A03835.02

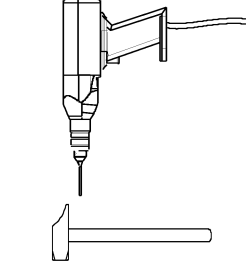
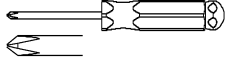
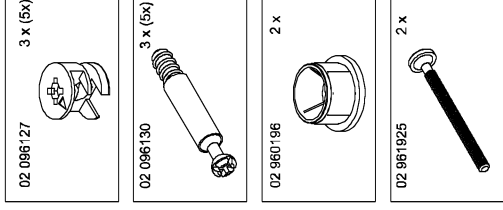
**röhr**

### Montageanleitung A03835.03

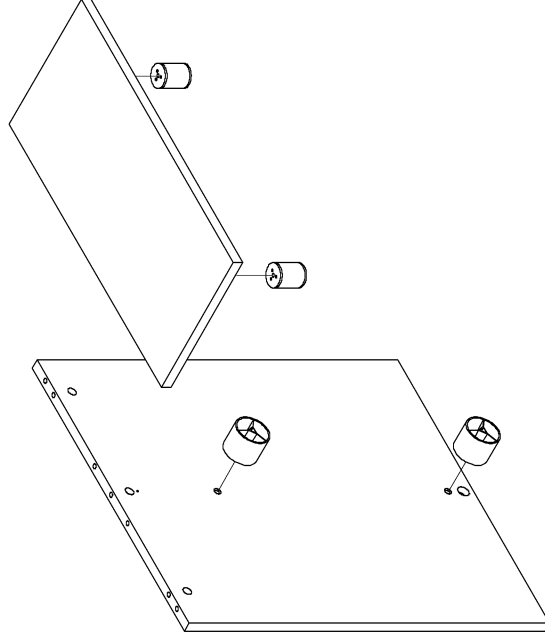
**röhr**

### Montageanleitung A03835.04

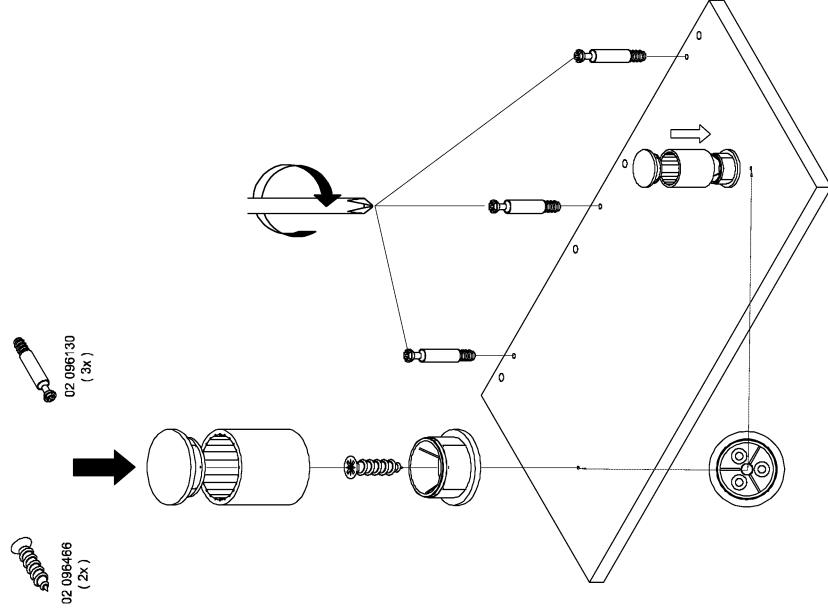

**röhr**

**Montageanleitung  
A03835.05**

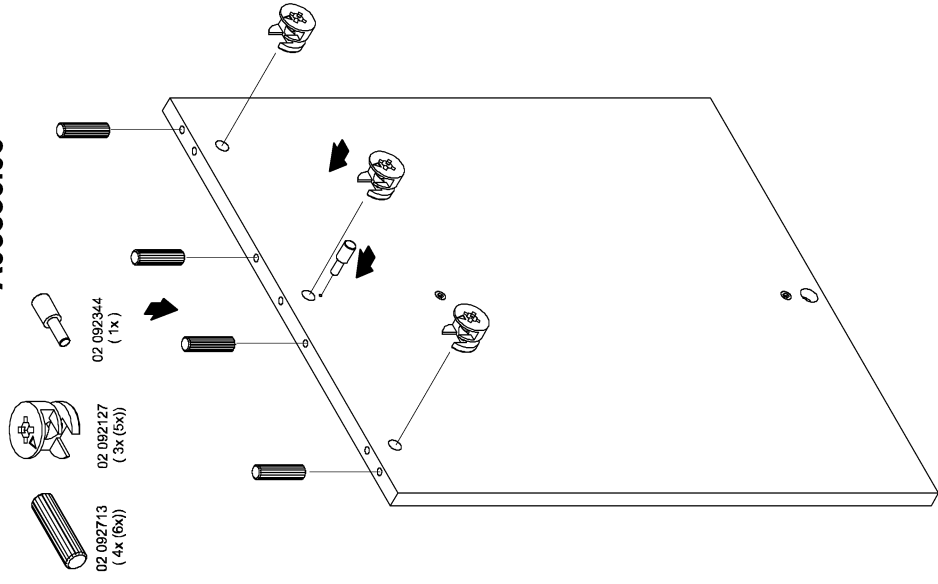

**röhr**

**Montageanleitung  
A03835.06**

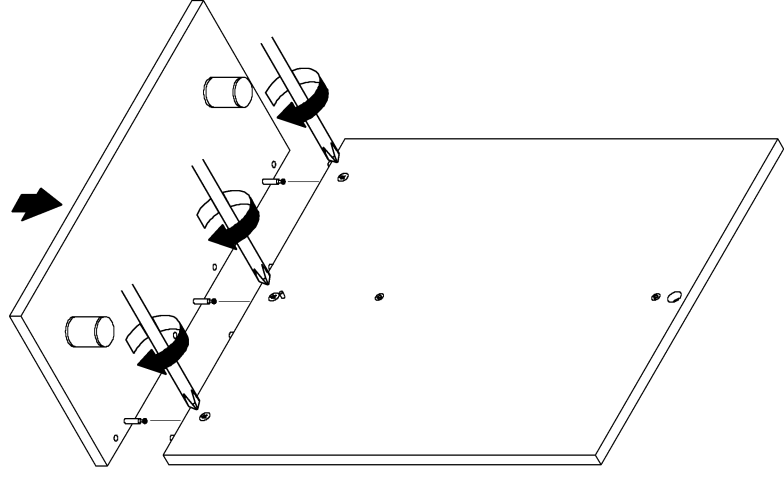

**röhr**

**Montageanleitung  
A03835.07**

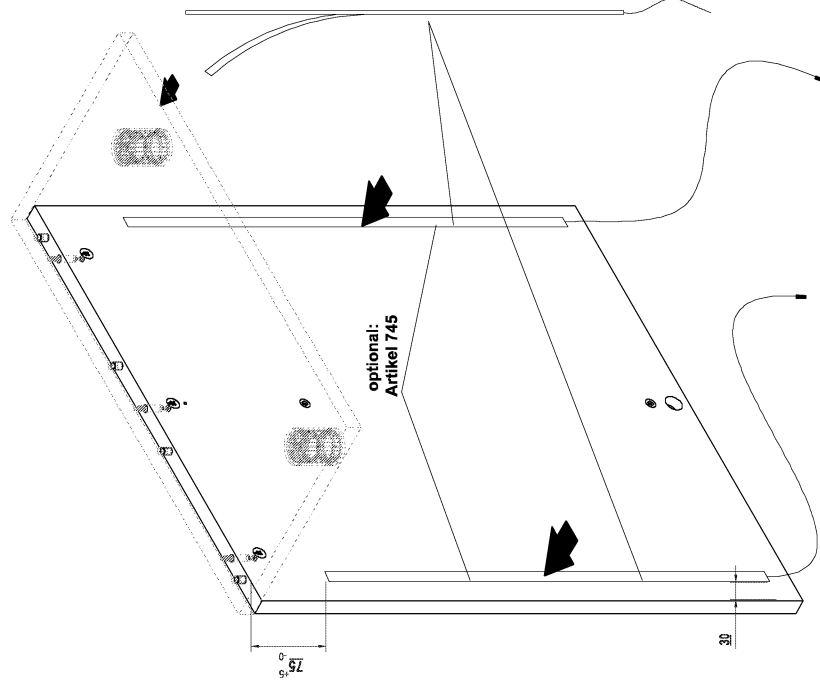

**röhr**

**Montageanleitung  
A03835.08**

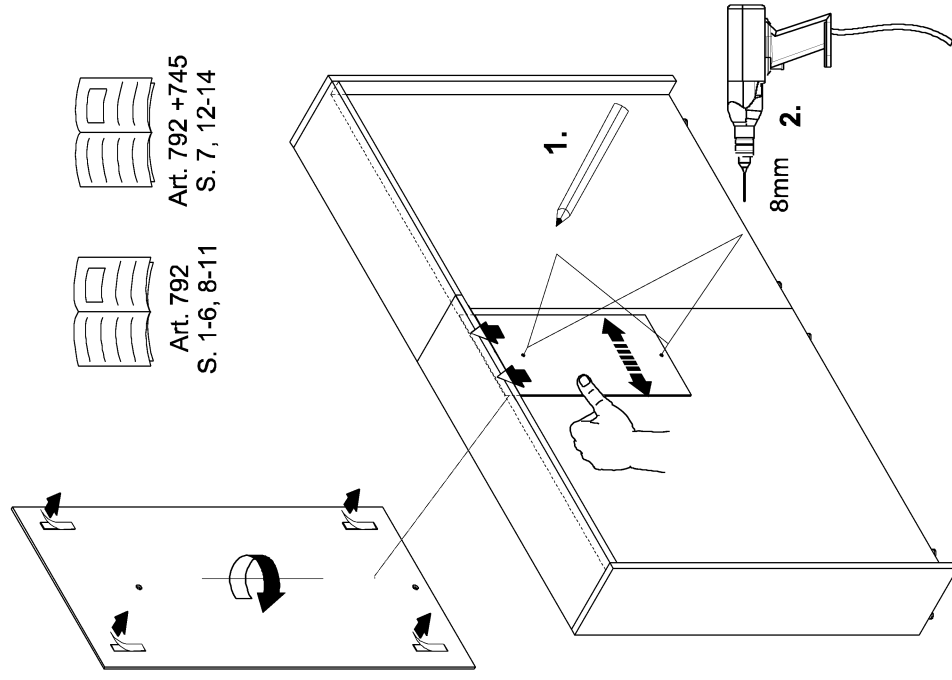

**röhr**

Montageanleitung  
A03835.09



02 961925  
(2x)

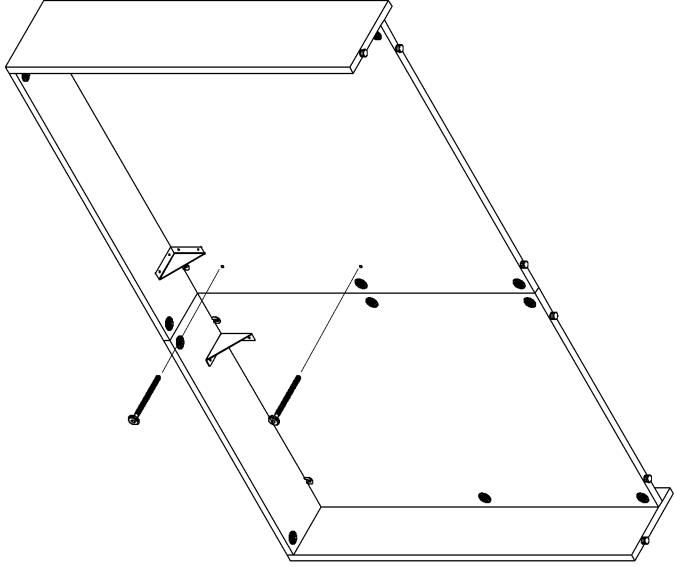

**röhr**

Montageanleitung  
A03835.10

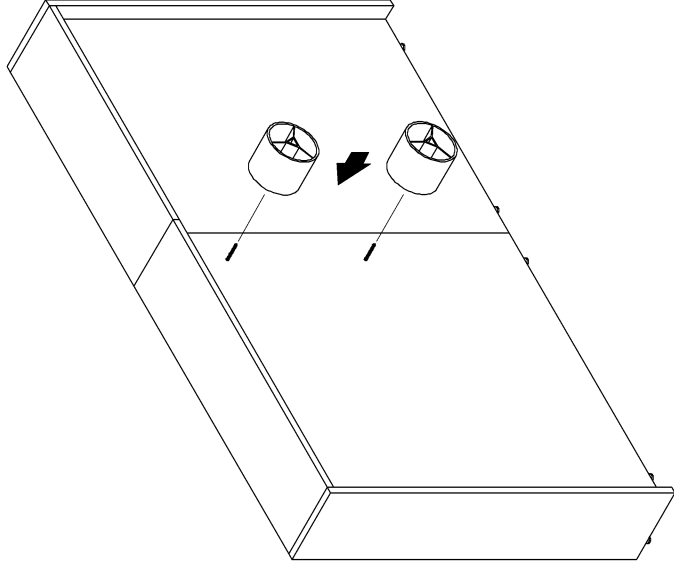

**röhr**

Montageanleitung  
A03835.11

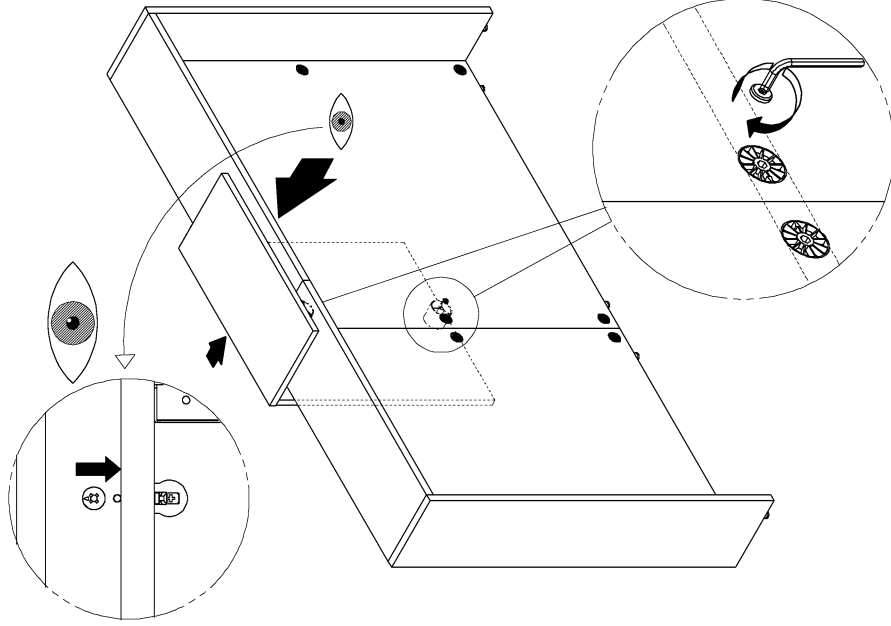

**röhr**

Montageanleitung  
A03835.12

bei Artikel 745

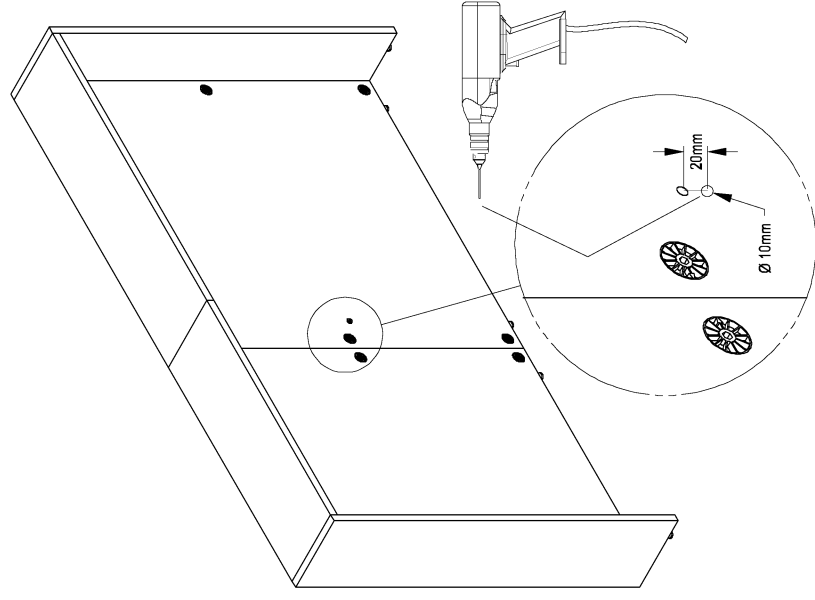

**röhr**

Montageanleitung  
A03835.13

bei Artikel 745

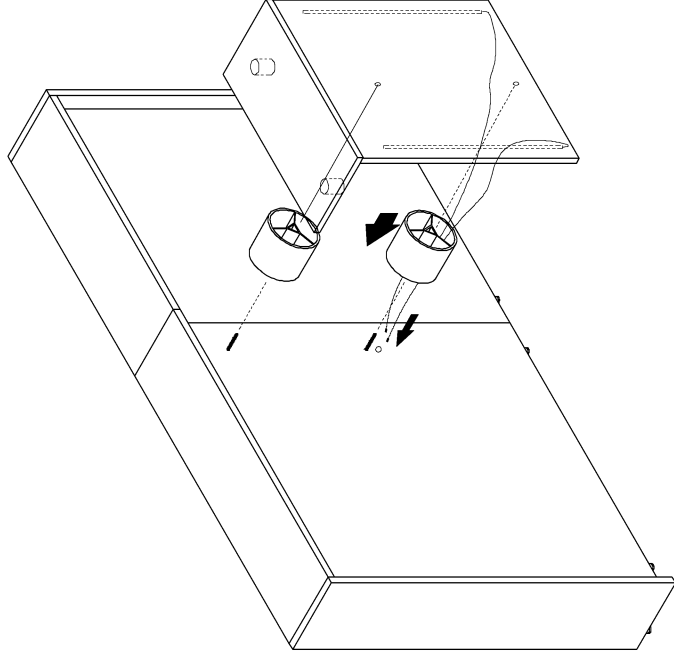

**röhr**

Montageanleitung  
A03835.14

bei Artikel 745

