

röhr

Röhr-Bush GmbH & Co. KG
 Dammstraße 32
 33397 Rietberg
 Germany
 Fon +49 (0) 2944 981 198
 Fax +49 (0) 2944 981 310

Schreibtisch A04246.01

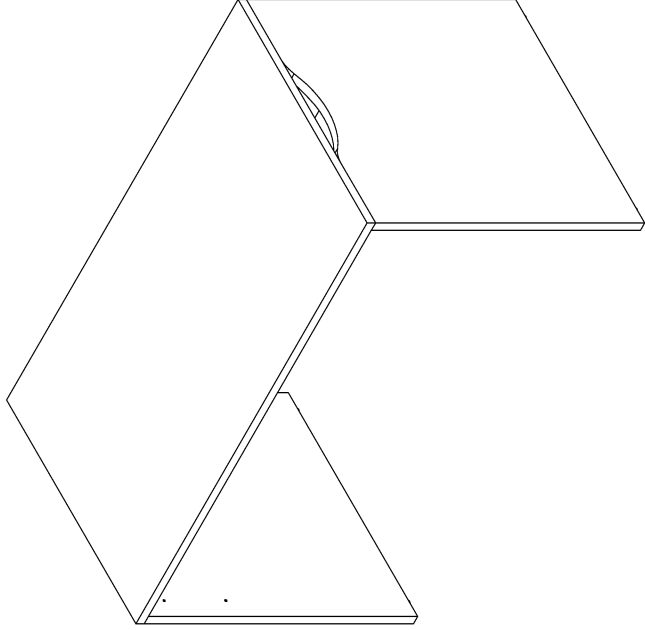

Bitte unbedingt lesen. Bei Nichtbeachtung können wir keine Gewährleistung übernehmen!
 Bitte bewahren Sie diese Montageanleitung für die Produktkennung (Produktsicherheitsgesetz) und für evtl. spätere Rückfragen (wie z. B. Demontage) auf.
 Bei Weitergabe bzw. Übergabe des Artikels übergeben Sie auch diese Montageanleitung.
 Attention! It is essential to read this. In case of non-compliance we cannot accept any liability.
 Please retain this assembly instruction for product identification and all future references e.g. disassembly.

With all transfers or deliveries of this item this assembly instruction should always be forwarded.
 0230123

röhr

Montageanleitung A04246.02

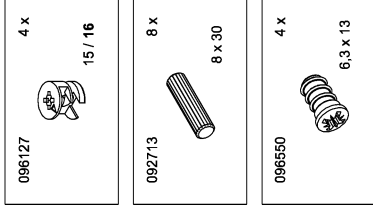

Beschlägen können aufgrund von standardisierten Produktionsprozessen einen Überschuss an Beschlägen enthalten!
 The content of fittings may be higher than listed because of universal fitting-packages!

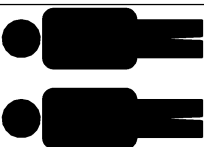
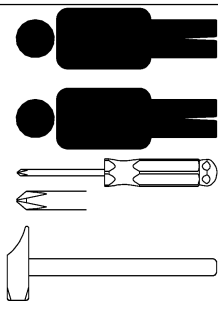
**röhr**

Montageanleitung A04246.03

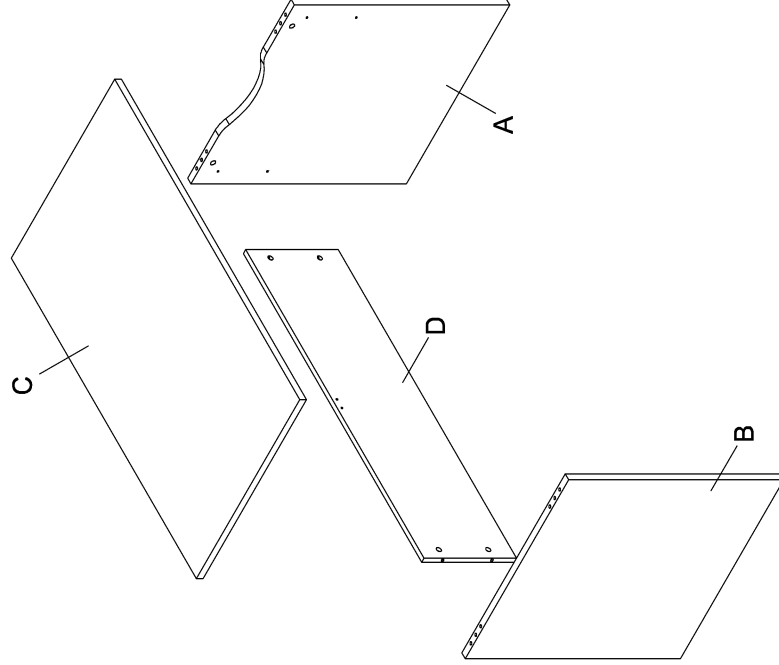
**röhr**

Montageanleitung A04246.04

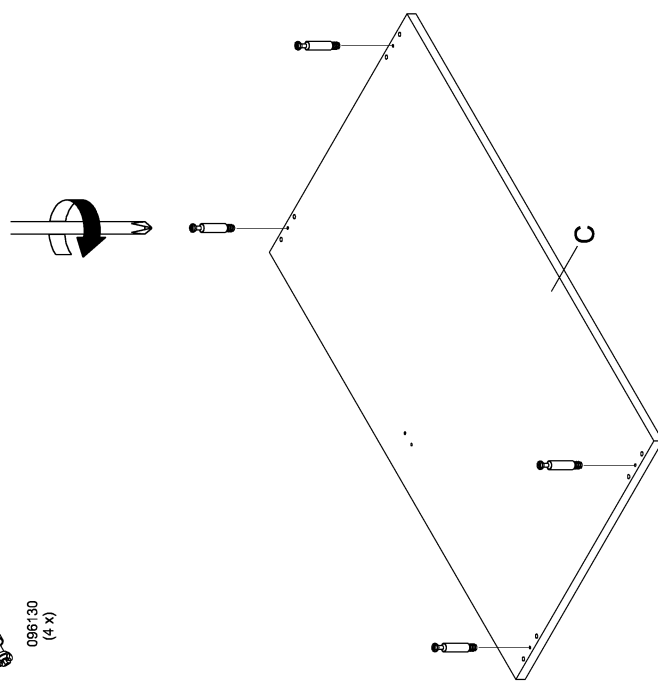
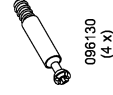

röhr

**Montageanleitung
A04246.05**

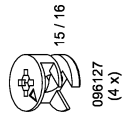

096127
(4 x)

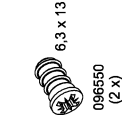

096550
(2 x)



096115
(1 x)

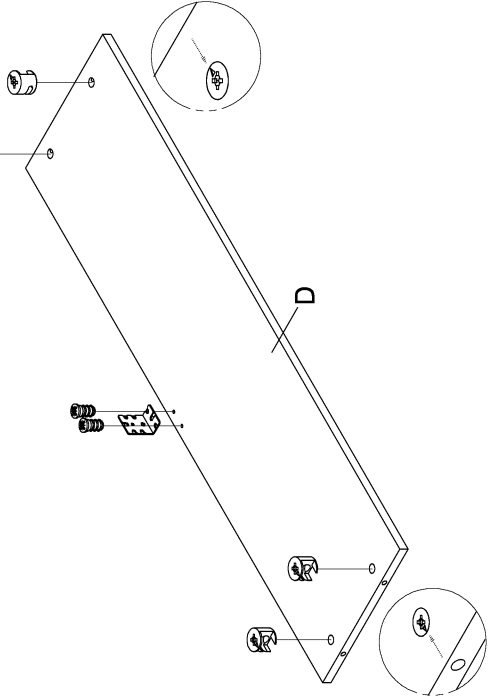

Kabeldurchlass rechts oder links?
Cable passage right or left?

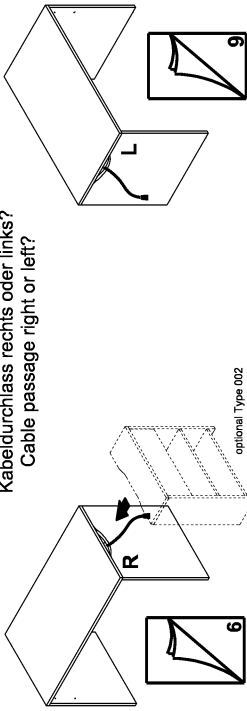

optional Type 002

röhr

**Montageanleitung
A04246.06**

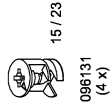

096131
(4 x)

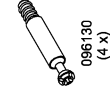

096130
(4 x)



092713
(8 x)

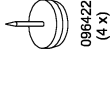

096422
(4 x)

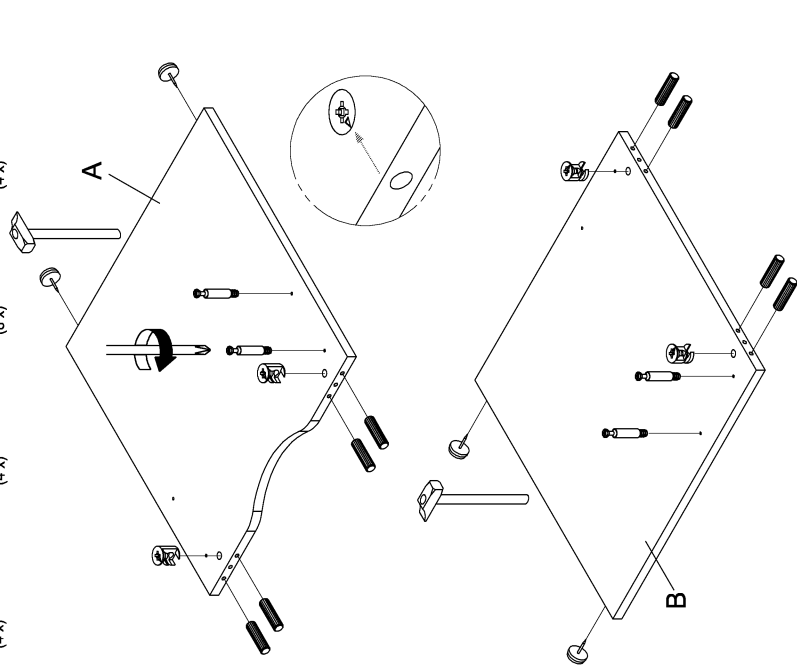

röhr

**Montageanleitung
A04246.07**

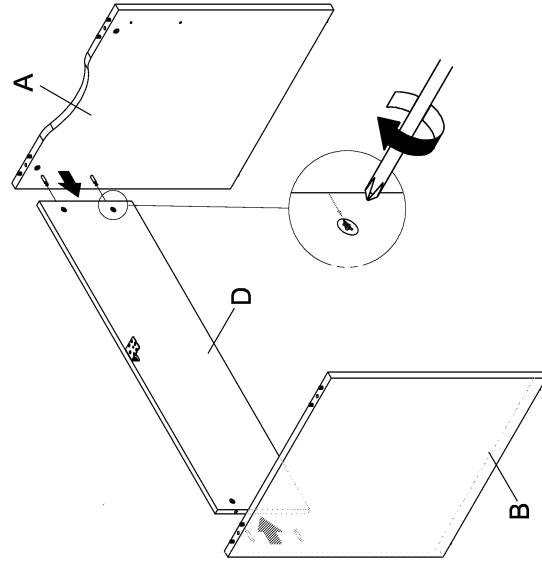

röhr

**Montageanleitung
A04246.08**



096550
(2 x)

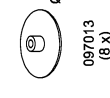

097013
(8 x)

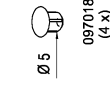

097018
(4 x)

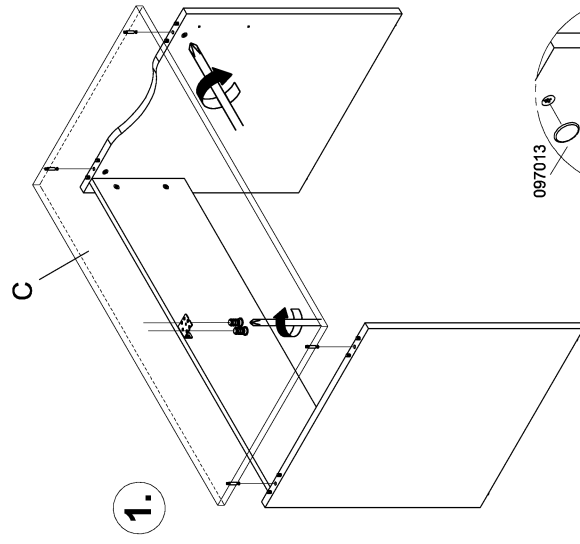

2.

097013

097018

röhr

Montageanleitung
A04246.09

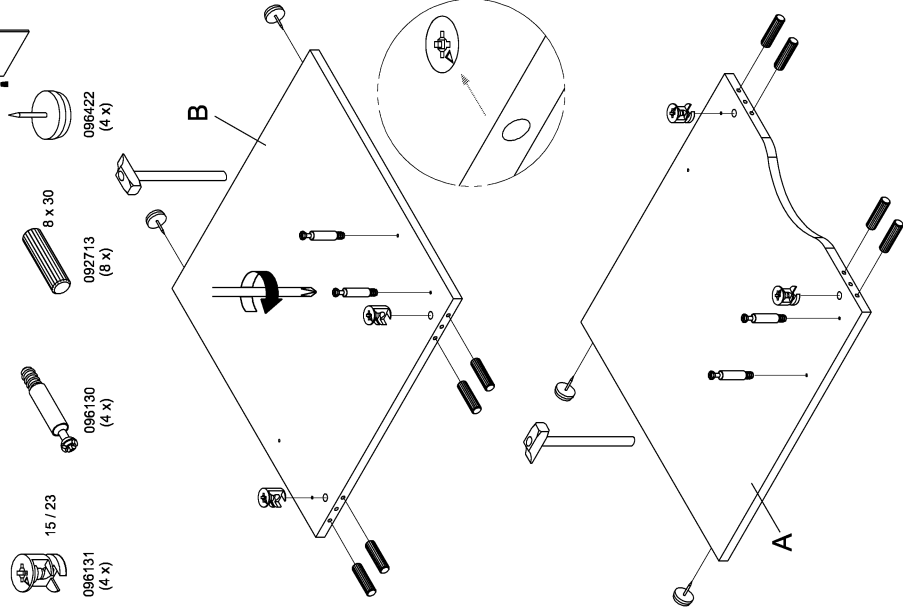

röhr

Montageanleitung
A04246.10

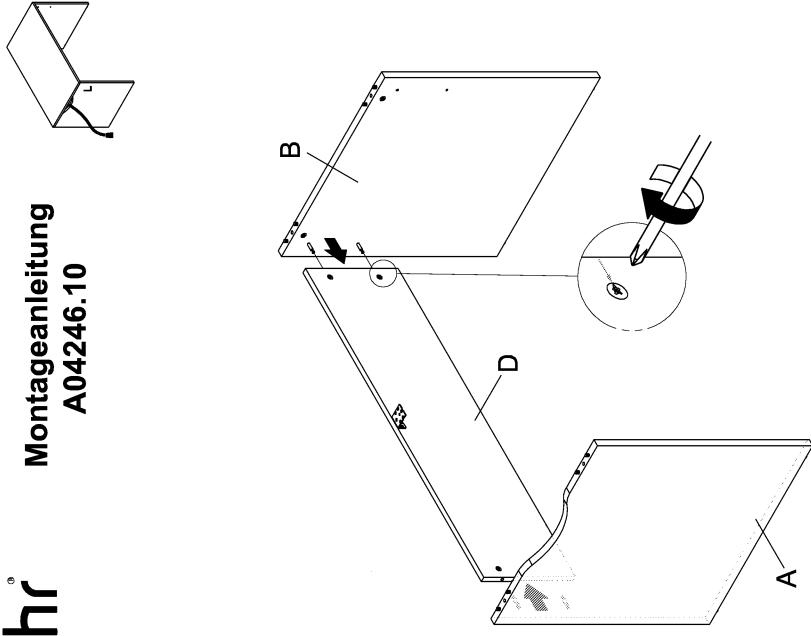

röhr

Montageanleitung
A04246.11

